



NMT SMART 40/60 F220

979527136

NMT SMART / Electronically regulated circulating pump

GENERAL

Part number	979527136		
Part name	NMT SMART 40/60 F220		
Seal type	EEI		0.21
Net weight	7.60 [kg]		
H max	6.2 [m]	H min	0.0 [m]
Q max	9.9 [m3/h]	Q min	0.0 [m3/h]
	[%]		
Noise	≤43 dB(A)		

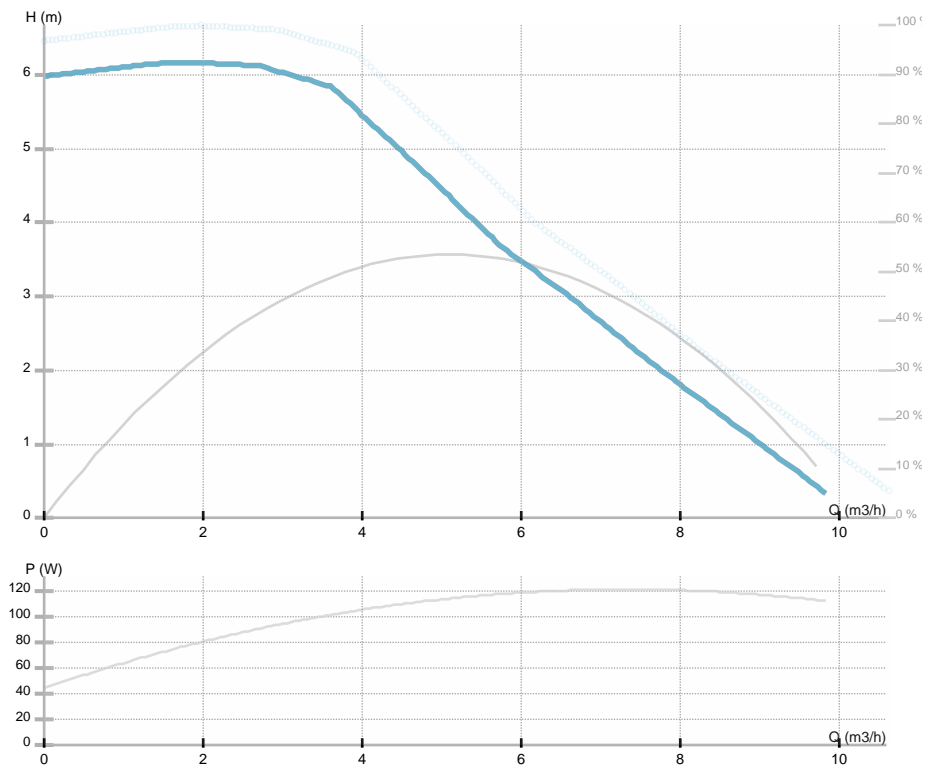

ELECTRICAL DATA

Power supply	1~230 V
Mains frequency	50/60 Hz
Motor power	110 [w]
RPM	3400 [1/min]
Insulation class	F
Declared current	1.0 [A]
Declared protection	IP44
Thermal protection	NTC
Frame size	
Motor IE class	

INSTALLATION

Fluid	Water VDI 2035, glycol 40%
Fluid temperature	-10.0 ÷ 110.0 [°C]
Ambient temp.range	40 deg C
Length	220 [mm]
DN	40 [mm]
Connector	PN 6/10
Connection	PN 6/10
Max pressure	1.0 MPa

MATERIAL

Bearing material	Graphite
Impeller material	PES GF 30
Hydraulics material	Gray cast iron
Shaft material	AISI 420

NMT SMART 40/60 F220

979527136

NMT SMART / Electronically regulated circulating pump





NMT SMART 40/60 F220

979527136

NMT SMART / Electronically regulated circulating pump

Dimension drawing

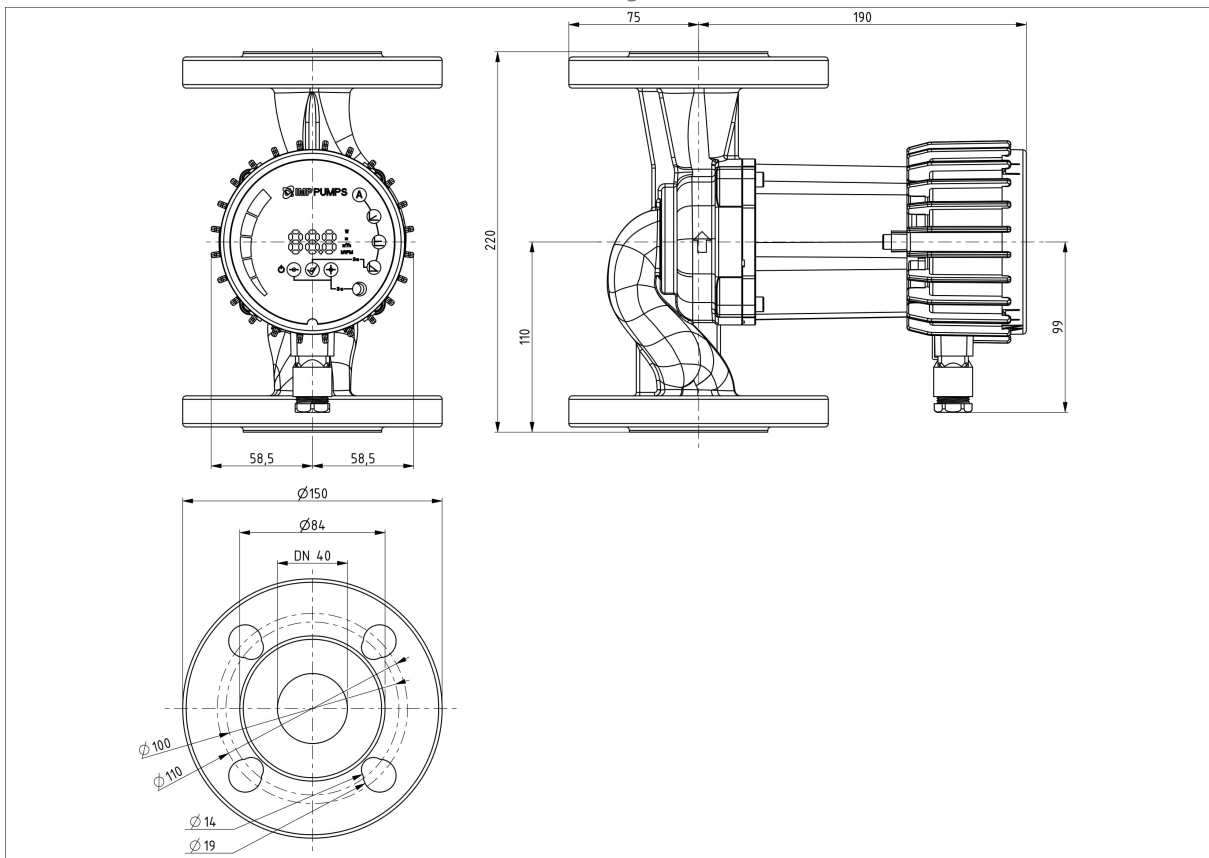

DN=40 h=220 a=75 l=190



NMT SMART 40/60 F220

979527136

NMT SMART / Electronically regulated circulating pump

Electrical wiring

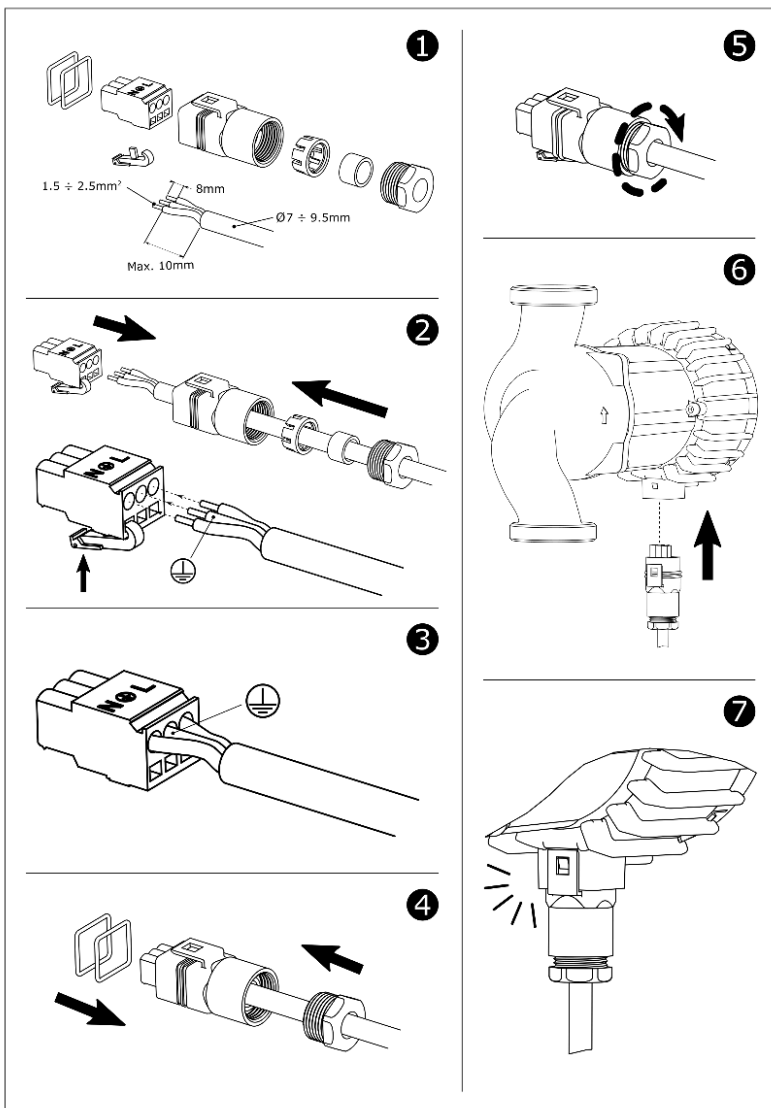



NMT SMART 40/60 F220

979527136

NMT SMART / Electronically regulated circulating pump