



## NMT SMART C 32/120 F220

979524540

NMT SMART C / Electronically regulated circulating pump - communication

Heating/cooling, Klimatizacija

### GENERAL

Part number	<b>979524540</b>		
Part name	<b>NMT SMART C 32/120 F220</b>		
Seal type	EEl		<b>0.2</b>
Net weight	<b>7.50 [kg]</b>		
H max	<b>12.07 [m]</b>	H min	<b>0.0 [m]</b>
Q max	<b>10.77 [m3/h]</b>	Q min	<b>0.0 [m3/h]</b>
	<b>50 [%]</b>		
Noise	<b>≤43 dB(A)</b>		

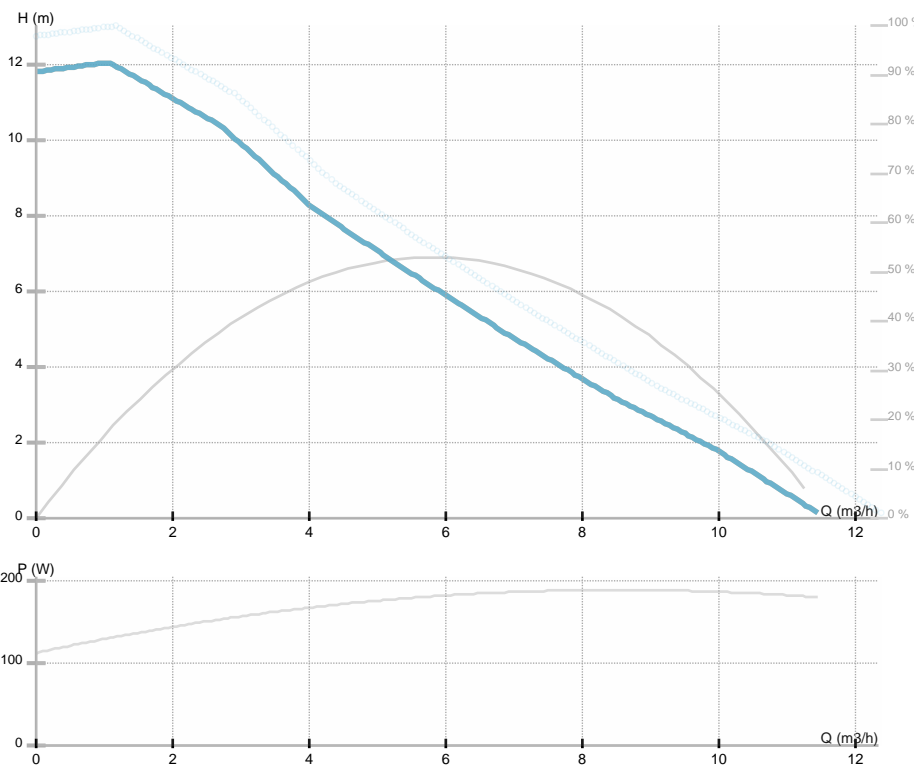

### ELECTRICAL DATA

Power supply	<b>1~230 V</b>
Mains frequency	<b>50/60 Hz</b>
Motor power	<b>180 [w]</b>
RPM	<b>4800 [1/min]</b>
Insulation class	<b>F</b>
Declared current	<b>1.5 [A]</b>
Declared protection	<b>IP44</b>
Thermal protection	<b>NTC</b>
Frame size	
Motor IE class	

### INSTALLATION

Fluid	<b>Water VDI 2035, glycol 40%</b>
Fluid temperature	<b>-10.0 ÷ 110.0 [°C]</b>
Ambient temp.range	<b>40 deg C</b>
Length	<b>220 [mm]</b>
DN	<b>32 [mm]</b>
Connector	<b>PN 6/10</b>
Connection	<b>PN 6/10</b>
Max pressure	<b>1.0 MPa</b>

### MATERIAL

Bearing material	<b>Graphite</b>
Impeller material	<b>PES GF 30</b>
Hydraulics material	<b>Gray cast iron</b>
Shaft material	<b>AISI 420</b>

## **NMT SMART C 32/120 F220**

979524540

NMT SMART C / Electronically regulated circulating pump - communication  
Heating/cooling, Klimatizacija





## NMT SMART C 32/120 F220

979524540

NMT SMART C / Electronically regulated circulating pump -  
communication

Heating/cooling, Klimatizacija

Dimension drawing

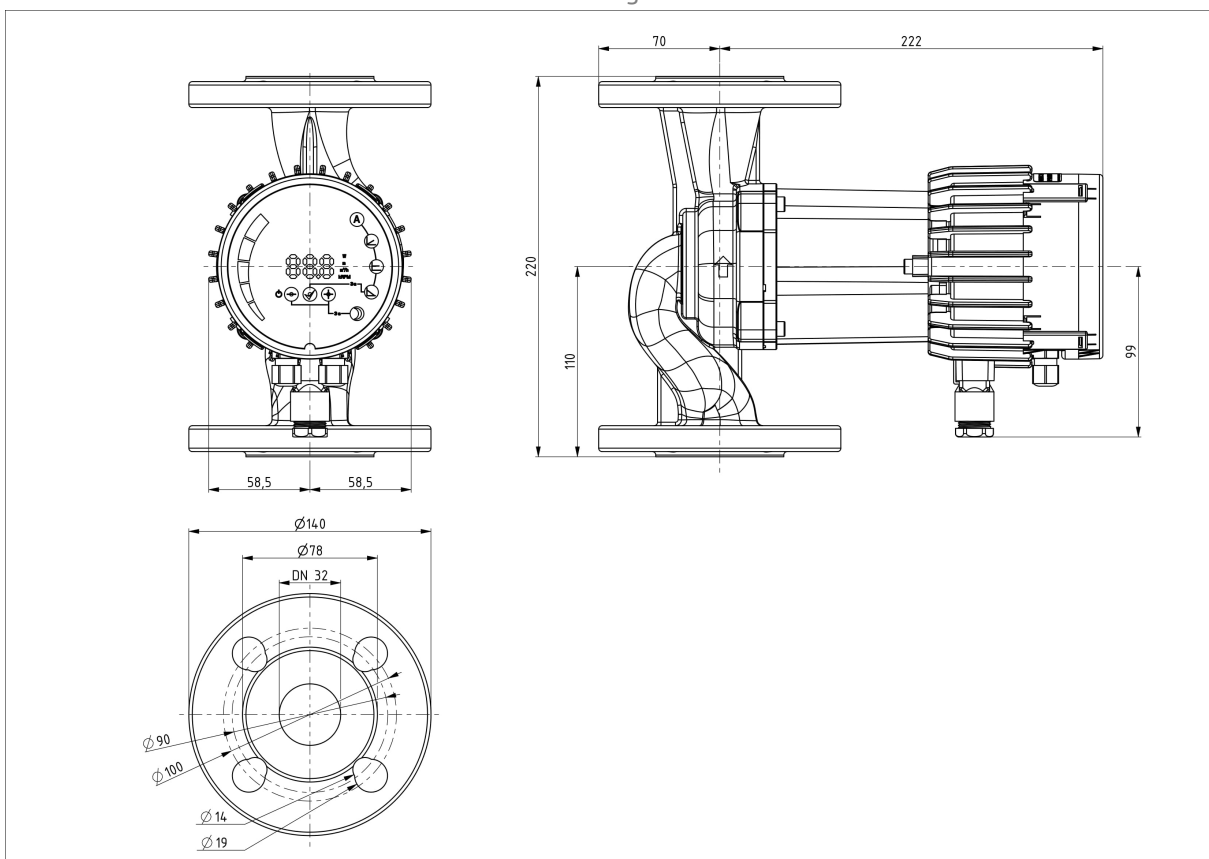



## NMT SMART C 32/120 F220

979524540

NMT SMART C / Electronically regulated circulating pump - communication

Heating/cooling, Klimatizacija

### Electrical wiring

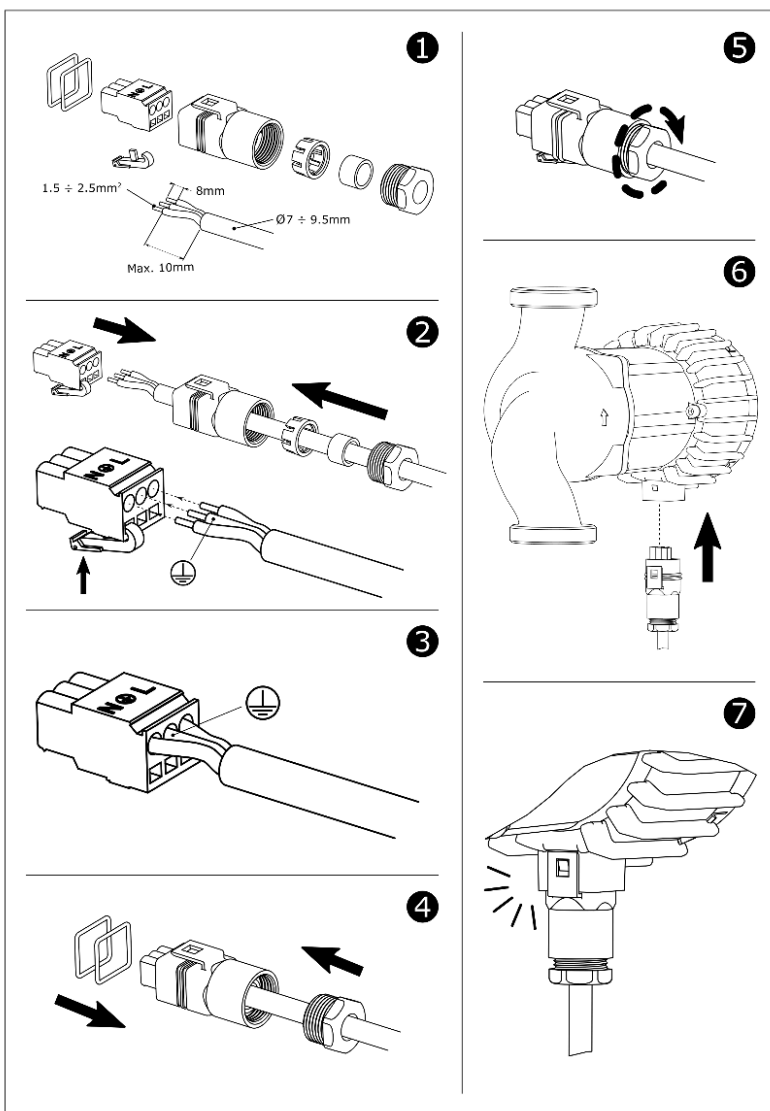



## **NMT SMART C 32/120 F220**

979524540

NMT SMART C / Electronically regulated circulating pump -  
communication

Heating/cooling, Klimatizacija